

Solar Charge Controller User Manual

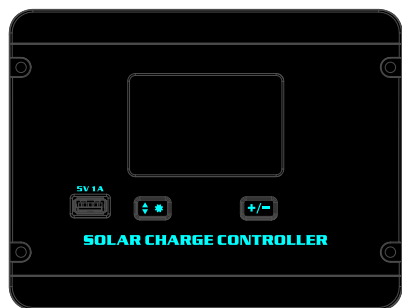

CONTROLLER FEATURES

- 1) PCBA common negative design, necessary for all negative grounded solar power systems.
- 2) 12/24V auto recognition for Flooded, AGM and GEL batteries. Lithium battery must be manually set. 30A rated charge current.
- 3) PWM 3-phase charging: equalize - boost - float (for Flooded, AGM and GEL).
- 4) User friendly with easy to use settings. For Lithium battery systems, there are options for parameter adjustments.
- 5) Flush mount design for easy installation.
- 6) Back lit LCD display with informative pages (system status, current, voltage, voltage value settings, etc).
- 7) Easy to use buttons for turning pages and controller parameter settings.
- 8) 5V USB port for mobile device charging. (plug and play)
- 9) Temperature compensation for better battery maintenance in extreme cold or hot environments.
- 10) Multiple built in protections including solar reverse connection, battery reverse connection, battery over-discharge, battery over voltage, load short circuit.

INSTALLATION NOTES

1) IMPORTANT REMINDERS

- * The battery must always be connected to the controller first.
- * Please note that the maximum solar (PV) input voltage is 55V open circuit voltage (OCV), so do not use solar module(s) with working voltage (VMP) of more than 40V (refer to solar (PV) module specs).
- * Please note the maximum solar (PV) input power is 450W/12V or 900W/24V. Please do not exceed the rated power.
- * Do not change any settings in the "LI" battery mode if you are not using a lithium battery.
- * In the LI battery mode, you must set the battery system voltage (12 or 24V) manually.
- * If you would like to check the information in the "LI" battery mode settings, but not alter any settings, then you MUST remember to keep the right system voltage set (12 or 24V) before exiting from the settings.

2) HARDWARE SUGGESTIONS

- * For maximum PWM charge efficiency, we suggest using solar modules with an output of 18V (VMP) for a 12V battery system, and 36V (VMP) module for 24V battery systems. You can still use modules with lower voltages but it may lead to a slightly lower charge efficiency. In all cases the solar (PV) input voltage (VMP) must be higher than the battery system voltage.
- * For safety and protection we suggest using a DC breaker or fuse between both the solar and the controller, as well as between the controller and the battery.

CONTROLLER ILLUSTRATION

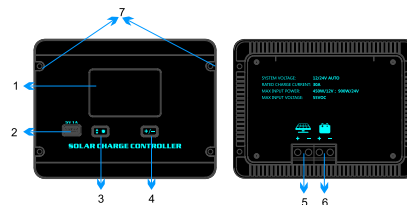

1	LCD Display	5	Solar input wiring terminal
2	USB Port	6	Battery wiring terminal
3	Set/Page button	7	Installation holes
4	Parameter set button		

WIRING SEQUENCES

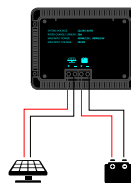

- First: Connect the battery first, please choose cable accordingly.
- Last: Connect the solar panel second, please choose cable accordingly.

LCD DISPLAY ILLUSTRATIONS

1) Display Overview

You can check system information in the LCD display, including PV input voltage, charge current, battery voltage, battery capacity, controller temperature, error code and battery setting pages. Here is an overall picture of the LCD display:

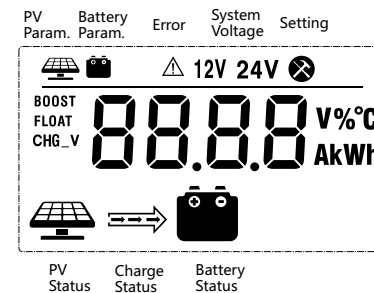

2) Solar (PV), Battery & Charge Indications

ICON	ITEM	INDICATION STATUS	INDICATION REMARK
	PV Indication	Steady ON	PV volt higher than light control volt
		OFF	PV volt lower than light control volt
		Slow flash ON	Charging
		Fast blink ON	PV over voltage
	Battery Indication	Steady ON	Battery is ok
		OFF	Battery is not ok
		Fast blink ON	Battery over discharge
	Charge Indication	Floating	Charging
		No float	No charge

Thanks for your purchase of our solar charge controller!

This device is a PWM 12/24V 30A charge controller ideal for many applications. It's flush mount design makes it perfect for solar power systems in RV's and boats. Please be sure to read through the following pages and familiarize yourself with the features and settings of the controller.

OPERATION & SETTINGS PAGES

1) Button Setting Info

There are 2 buttons on the controller for operations and settings. Check the below diagram for setting details:

BUTTON	SETTING STATUS	PRESS	FUNCTION
⬆️ ⚙️	In Setting	Long press	Enter page not for settings
		Short press	Enter next page for settings
⬆️ ⚙️	Not in Setting	Long press	Enter page for settings
		Short press	Enter next page not for settings
⊕/⊖	In Setting	Long press	No function
		Short press	To adjust parameter
		Long press	No function
⊕/⊖	Not in Setting	Long press	No function
		Short press	No function

Remarks: "In Setting" means the user is in process of setting parameters.

2) Information Pages:

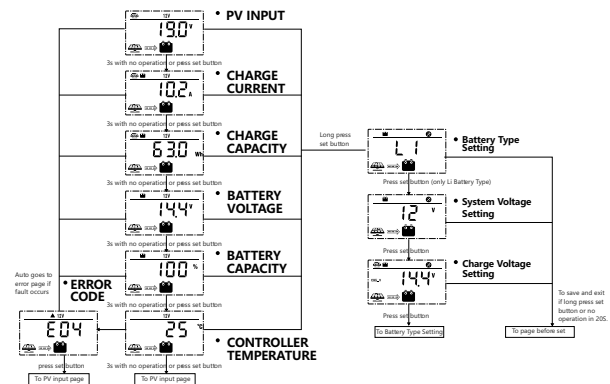

BATTERY TYPE & PARAMETER SETTINGS

1) Battery Type Setting

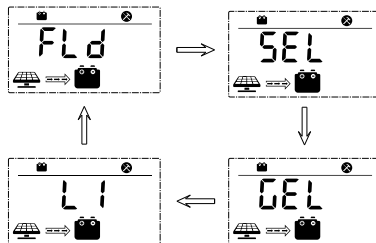

DISPLAY	BATTERY TYPE	REMARKS
FLD	Flooded Battery	Battery system voltage auto recognition; parameters default set.
SEL	Sealed/AGM Battery	
GEL	Gel Battery	
LI	Lithium Battery	System voltage, charge/discharge parameters adjustable.

2) Battery System Voltage Setting (only for lithium battery)

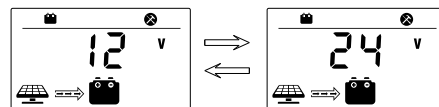

3) Charge Voltage Setting (only for lithium battery)

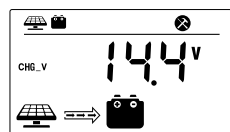

CONTROLLER ERROR INFO & RECOVERY

Due to a variety of potential issues, the controller may sometimes display an error code on the LCD screen. If this happens please refer to the below diagram:

CODE	ERROR	ANALYSIS	SOLUTION (Recovery)
E00	No Error	-	-
E01	Over-discharged	The battery has been discharged below normal ranges.	Recovered once battery voltage returns to normal range. An alternate charge source may be required depending on depth of discharge.
E02	Over voltage	The battery voltage exceeds the normal range.	Recovered after the battery voltage returns to the normal range. It is possible that the battery may be defective.
E06	Device over heating	Charge shuts down due to high temperature inside the controller	Recovered after temperature returns to the normal range.
E08	Input over load	The solar (PV) input power exceeds the rated value	Recovered after the solar (PV) input power is within the controller ratings.
E10	PV over voltage	The solar (PV) input voltage is too high.	Recovered after the solar (PV) input voltage is within the controller ratings.
E13	PV anti-connection	Solar (PV) module +- polarity reverse-connection	Correct the + and - solar connection.
E14	Battery anti-connection	Battery +- polarity reverse-connection	Correct the + and - battery connection.

CONTROLLER SPECIFICATIONS

ITEM	PARAMETERS			
Model No.	30A Charge Controller			
System Voltage	12V/24V			
No-load Loss	8ma (12V), 12ma (24V)			
Max PV Input Voltage	< 55Voc			
Rated Charge Current	30A			
Max PV Input Power	450W/12V; 900W/24V			
Battery Type Selection	FLD	SEL	GEL	LI
Equalize Charge Voltage	14.8V (12V) / 29.6V (24V)	14.6V (12V) / 29.2V (24V)	-	-
Boost Charge Voltage	14.6V (12V) / 29.2V (24V)	14.4V (12V) / 28.8V (24V)	14.2V (12V) / 28.4V (24V)	14.2V (12V) / 28.2V (24V) adjustable
Float Charge Voltage	13.8V (12V) / 27.6V (24V)			-
Boost Charge Recovery Volt	13.2V (12V) / 26.4V (24V)			-
Over Discharge Recovery Volt.	12.6V (12V) / 25.2V (24V)			11.0V (12V) / 21.0V (24V) *auto adjusted to over-discharge volt
Over Discharge Voltage	11.1V(12V) / 22.2V(24V)			10.0V (12V) / 20.0V (24V) adjustable
Light Control Voltage	5V(12V system), 10V(24V system)			
Light Control Delay Time	10s			
Operation Temperature	-35°C ~ +45°C			
IP Protection	IP32			
Net Weight	0.45kg			
Controller Size	170*130*48mm			